

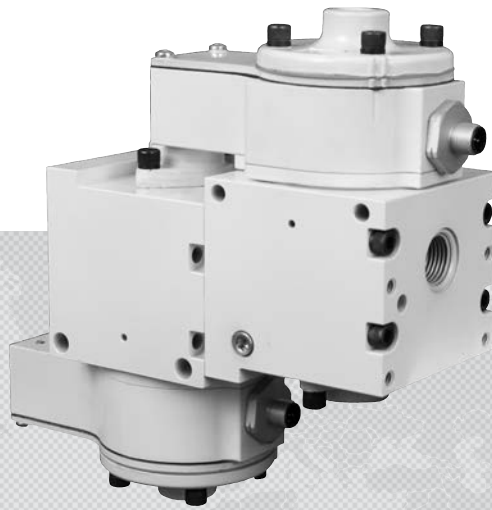

PRODUCT INFORMATION

CYLINDER LOAD HOLDING PO CHECK SENSING VALVES

SV27 SERIES



ROSS CONTROLS

Pilot Operated Check Sensing Valves

SV27 Series Load Holding

2-Way 2-Position Valves, Solenoid Pilot Controlled				
Port Size	Body Size	Valve Model Number*	C _v	Weight lb (kg)
1, 2			1-2	
1/2	3/4	SV27NC115408CSAA**	4.5	5.0 (2.3)
3/4	3/4	SV27NC115508CSAA**	8.3	5.0 (2.3)
1	3/4	SV27NC115608CSAA**	10.3	5.0 (2.3)
1	1¼	SV27NC117608CSAA**	20	12.5 (5.6)
1¼	1¼	SV27NC117708CSAA**	29	12.5 (5.6)
1½	1¼	SV27NC117808CSAA**	33	12.5 (5.6)

* NPT port threads. For BSPP threads, replace "N" in the model number with a "D", e.g., SV27DC115408CSAA1A.
 ** Insert voltage code: "1A"=110-120 volts AC, 50/60 Hz; "1D"= 24 volts DC; .e.g., SV27NC115408CSAA1A.
 For other voltages, consult ROSS.

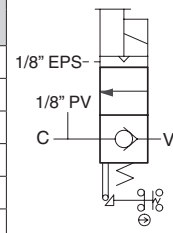

Valve Dimensions – inches (mm)

Body Size 3/4 (CNOMO Style Pilot)

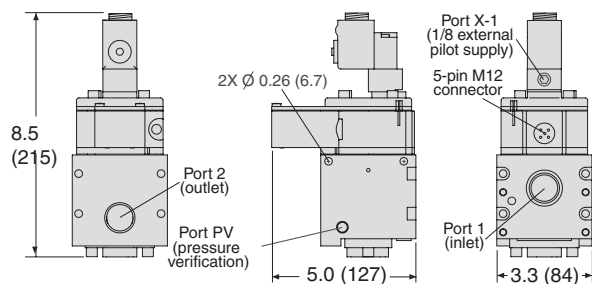

Body Size 1¼ (Pacer Style Pilot)

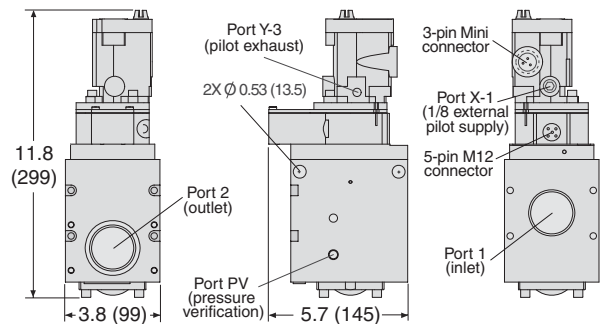

ACCESSORIES & OPTIONS

Pressure Switches	Connection Type	Model Number*	Port Threads
	EN 175301-803 Form A	586A86	1/8 NPT
	M12	1153A30	1/8 NPT

* Pressure switch closes on falling pressure of 5 psig (0.34 bar).

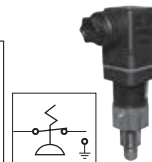
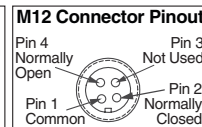
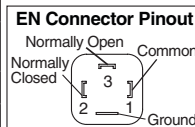

Indicator Light Kit for Pacer Style Pilot	
Kit Number	
24 volts DC	110-120 volts AC 50-60 Hz
862K87-W	862K87-Z

Preassembled Wiring Kits

Kit Number*	Length meters (feet)	Number of Cables
2239H77	4 (13.1)	2
2240H77	10 (32.8)	2

* Each cable has one connector.

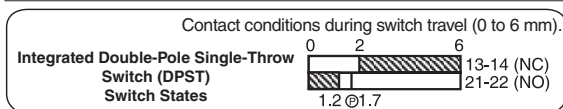

The wiring kits come with a cord grip on each cable. One cable has a 3-pin MINI connector for the solenoid and one has a 5-pin M12 (Micro) connector for the sensing switch.

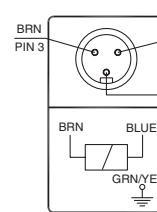

Solenoid Cable with 3-pin MINI Connector

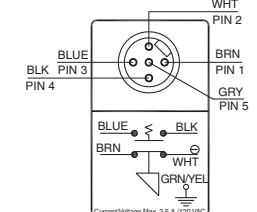

Sensing Switch Cable with 5-pin M12 Connector

STANDARD SPECIFICATIONS (for valves on this page):

Construction: Poppet.
Mounting Type: In-Line.
Solenoid: AC or DC power. Rated for continuous duty.
Standard Voltages: 24 volts DC; 110-120 volts AC, 50/60 Hz.
Power Consumption:
CNOMO Style: 11 VA inrush, 8.5 VA holding on 50 or 60 Hz; 6 watts on DC.
Pacer Style: 87 VA inrush, 30 VA holding on 50 or 60 Hz; 14 watts on DC.
Ambient Temperature: 40° to 120°F (4° to 50°C).
Media Temperature: 40° to 175°F (4° to 80°C).
Flow Media: Filtered air.
Inlet Pressure: 40 to 150 psig (2.8 to 10.3 bar).
Pilot Pressure: Must be equal to or greater than inlet pressure.

Switch Current/Voltage Max.: 2.5 A/120 volts AC.
Switch Current/Voltage Min.: 50 mA/24 volts DC.

NOTE: Electrical life of switch varies with conditions and voltage; rated in excess of 15 million cycles.

Functional Safety Data:

Category 2 PL d; B10d: Valve - 20,000,000, Switch - 2,000,000; PFHd: 2.35x10⁻⁷; MTTFd: 98.15 (n_{op}: 7360); DC (obtained by monitoring safety switch status): 90%; ROSS recommends testing the switch function and sealing for load holding valves every 8 hours.

Vibration/Impact Resistance: Calculated to BS EN 60068-2-27.

IMPORTANT NOTE: Please read carefully and thoroughly all of the **CAUTIONS, WARNINGS** on the inside back cover.



Online Version
Rev. 11/14/16

www.rosscontrols.com

Pilot Operated Check Sensing Valves Redundant

SV27 Series Load Holding

2-Way 2-Position Redundant Valves, Solenoid Pilot Controlled				
Port Size 1, 2	Body Size	Valve Model Number*	C _v	Weight lb (kg)
			1-2	
1/2	3/4	SV27NC555408CSAA**	3.8	10.0 (4.5)
3/4	3/4	SV27NC555508CSAA**	5.6	10.0 (4.5)
1	3/4	SV27NC555608CSAA**	8	10.0 (4.5)
1	1¼	SV27NC557608CSAA**	12	25.0 (11.3)
1¼	1¼	SV27NC557708CSAA**	19	25.0 (11.3)
1½	1¼	SV27NC557808CSAA**	22	25.0 (11.3)

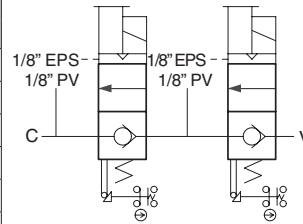

* NPT port threads. For BSPP threads, replace "N" in the model number with a "D", e.g., SV27DC555408CSAA1A.

** Insert voltage code: "1A"=110-120 volts AC, 50/60 Hz; "1D"= 24 volts DC; e.g., SV27NC555408CSAA1A. For other voltages, consult ROSS.

Valve Dimensions – inches (mm)

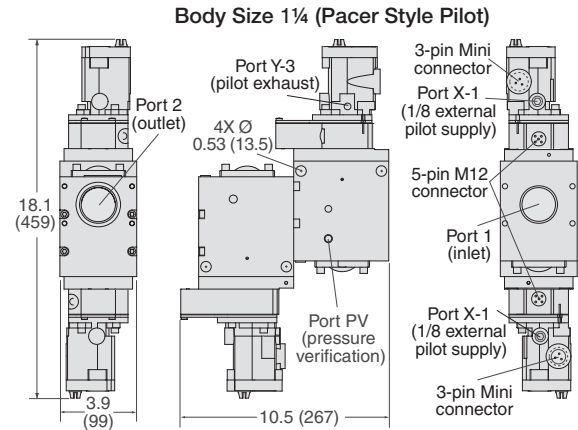
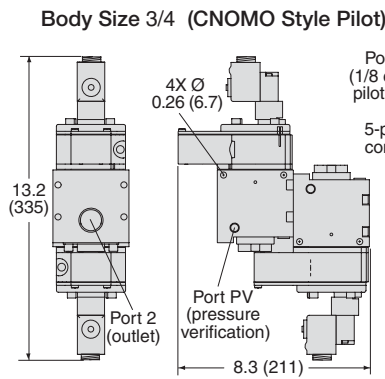

ACCESSORIES & OPTIONS

Pressure Switches	Connection Type	Model Number*	Port Threads
	EN 175301-803 Form A	586A86	1/8 NPT
	M12	1153A30	1/8 NPT

* Pressure switch closes on falling pressure of 5 psig (0.34 bar).

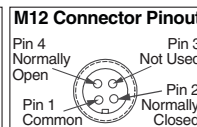
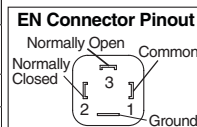

Indicator Light Kit for Pacer Style Pilot

Kit Number	
24 volts DC	110-120 volts AC 50-60 Hz
862K87-W	862K87-Z

F4

F

Preassembled Wiring Kits

Kit Number*	Length meters (feet)	Number of Cables
2239H77	4 (13.1)	2
2240H77	10 (32.8)	2

* Each cable has one connector.

The wiring kits come with a cord grip on each cable. One cable has a 3-pin MINI connector for the solenoid and one has a 5-pin M12 (Micro) connector for the sensing switch.

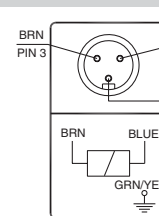

Solenoid Cable with 3-pin MINI Connector

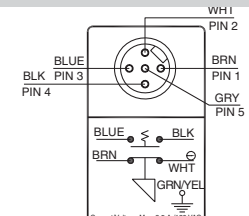

Sensing Switch Cable with 5-pin M12 Connector

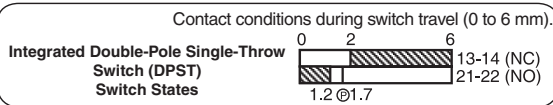

STANDARD SPECIFICATIONS (for valves on this page):

Construction: Poppet.
Mounting Type: In-Line.
Solenoid: AC or DC power. Rated for continuous duty.
Standard Voltages: 24 volts DC; 110-120 volts AC, 50/60 Hz.
Power Consumption:
CNOMO Style: 11 VA inrush, 8.5 VA holding on 50 or 60 Hz; 6 watts on DC.
Pacer Style: 87 VA inrush, 30 VA holding on 50 or 60 Hz; 14 watts on DC.
Ambient Temperature: 40° to 120°F (4° to 50°C).
Media Temperature: 40° to 175°F (4° to 80°C).
Flow Media: Filtered air.
Inlet Pressure: 40 to 150 psig (2.8 to 10.3 bar).
Pilot Pressure: Must be equal to or greater than inlet pressure.

Switch Current/Voltage Max.: 2.5 A/120 volts AC.
Switch Current/Voltage Min.: 50 mA/24 volts DC.

NOTE: Electrical life of switch varies with conditions and voltage; rated in excess of 15 million cycles.

Functional Safety Data:

Category 3 PL e; B10d: Valve - 20,000,000, Switch - 2,000,000; PFHd: 2.47x10⁻⁸; MTTFd: 100 (n_{op}: 7360); DC (obtained by monitoring safety switch status): 90%; ROSS recommends testing the switch function and sealing for load holding valves every 8 hours.

Vibration/Impact Resistance: Calculated to BS EN 60068-2-27.

IMPORTANT NOTE: Please read carefully and thoroughly all of the **CAUTIONS, WARNINGS** on the inside back cover.

Pilot Operated Check Sensing Valves

SV27 Series Load Holding

2-Way 2-Position Valves, Pressure Controlled				
Port Size	Body Size	Valve Model Number*	C _v	Weight lb (kg)
			1-2	
1/2	3/4	SV27NC115405ASAA	4.5	4.0 (1.8)
3/4	3/4	SV27NC115505ASAA	8.3	4.0 (1.8)
1	3/4	SV27NC115605ASAA	10.3	4.0 (1.8)
1	1¼	SV27NC117605ASAA	20	11.0 (5.0)
1¼	1¼	SV27NC117705ASAA	29	11.0 (5.0)
1½	1¼	SV27NC117805ASAA	33	11.0 (5.0)

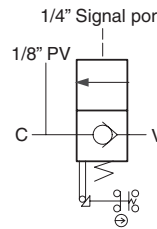

* NPT port threads. For BSPP threads, replace "N" in the model number with a "D", e.g., SV27DC115405ASAA.

Valve Dimensions – inches (mm)

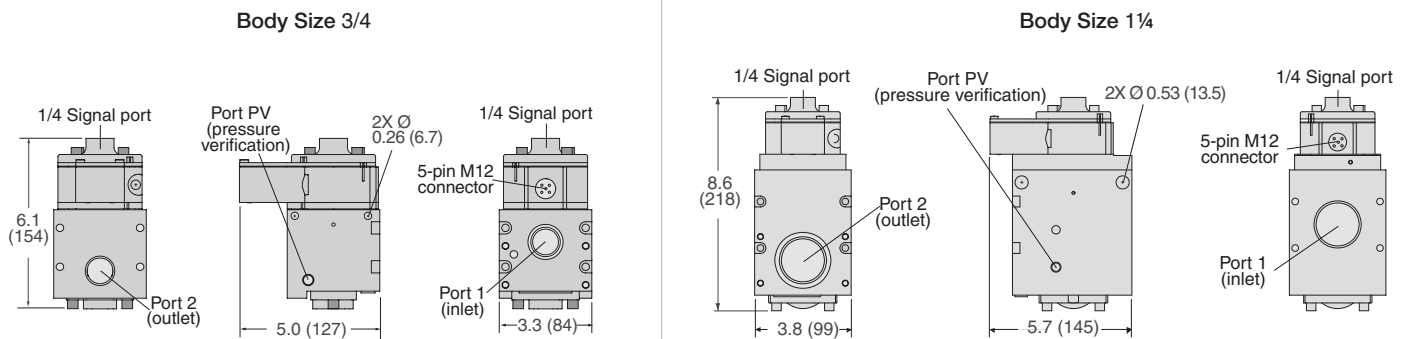

F4

ACCESSORIES & OPTIONS

Pressure Switches	Connection Type	Model Number*	Port Threads
	EN 175301-803 Form A	586A86	1/8 NPT
	M12	1153A30	1/8 NPT

* Pressure switch closes on falling pressure of 5 psig (0.34 bar).

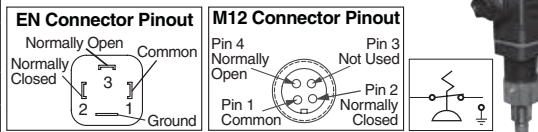

F

Preassembled Wiring Kits

Kit Number*	Length meters (feet)	Number of Cables
2241H77	4 (13.1)	1
2242H77	10 (32.8)	1

* Each cable has one connector.

The wiring kits include one cable with a 5-pin M12 connector for the sensing switch, and a cord grip.

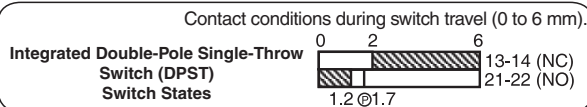

Sensing Switch Cable with 5-pin M12 Connector

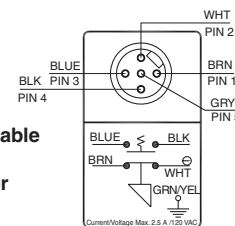

STANDARD SPECIFICATIONS (for valves on this page):

- Construction:** Poppet.
- Mounting Type:** In-Line.
- Ambient Temperature:** 40° to 120°F (4° to 50°C).
- Media Temperature:** 40° to 175°F (4° to 80°C).
- Flow Media:** Filtered air.
- Inlet Pressure:** 40 to 150 psig (2.8 to 10.3 bar).
- Pilot Pressure:** Must be equal to or greater than inlet pressure.
- Switch Current/Voltage Max.:** 2.5 A/120 volts AC.
- Switch Current/Voltage Min.:** 50 mA/24 volts DC.

NOTE: Electrical life of switch varies with conditions and voltage; rated in excess of 15 million cycles.

Functional Safety Data:

Category 2 PL d; B10d: Valve - 20,000,000, Switch - 2,000,000; PFHd: 2.35x10⁻⁷; MTTFd: 98.15 (n_{op}: 7360); DC (obtained by monitoring safety switch status): 90%; ROSS recommends testing the switch function and sealing for load holding valves every 8 hours.
Vibration/Impact Resistance: Calculated to BS EN 60068-2-27.

IMPORTANT NOTE: Please read carefully and thoroughly all of the **CAUTIONS, WARNINGS** on the inside back cover.



Online Version
Rev. 11/14/16

www.rosscontrols.com

F4.15

Pilot Operated Check Sensing Valves Redundant

SV27 Series Load Holding

2-Way 2-Position Valves, Pressure Controlled				
Port Size	Body Size	Valve Model Number*	C _v 1-2	Weight lb (kg)
1/2	3/4	SV27NC555405ASAA	3.8	9.0 (4.1)
3/4	3/4	SV27NC555505ASAA	5.6	9.0 (4.1)
1	3/4	SV27NC555605ASAA	8	9.0 (4.1)
1	1¼	SV27NC557605ASAA	12	22.0 (10.0)
1¼	1¼	SV27NC557705ASAA	19	22.0 (10.0)
1½	1¼	SV27NC557805ASAA	22	22.0 (10.0)

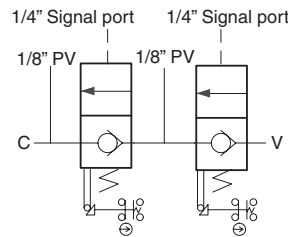

* NPT port threads. For BSP threads, replace "N" in the model number with a "D", e.g., SV27DC555405ASAA.

Valve Dimensions – inches (mm)

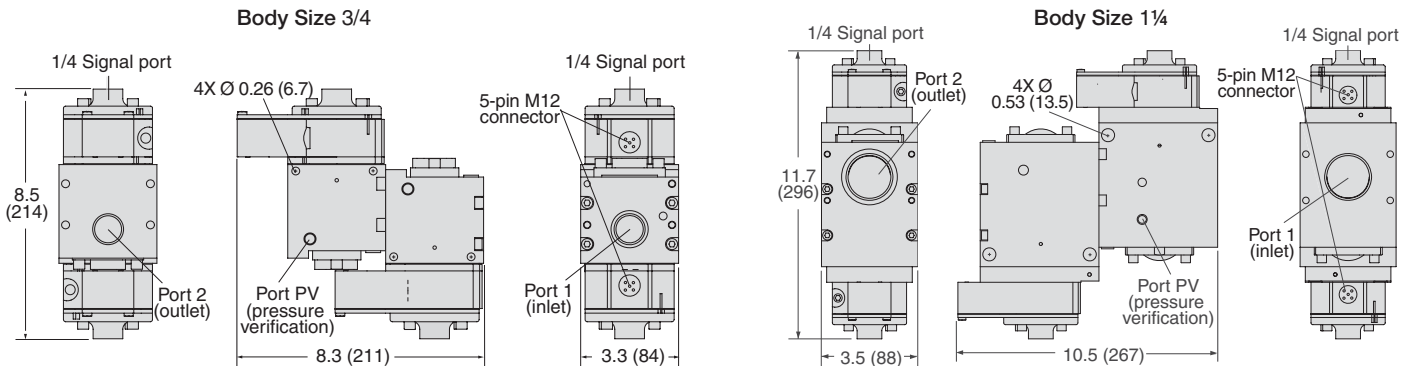

F4

ACCESSORIES & OPTIONS

Pressure Switches	Connection Type	Model Number*	Port Threads
	EN 175301-803 Form A	586A86	1/8 NPT
	M12	1153A30	1/8 NPT

*Pressure switch closes on falling pressure of 5 psig (0.34 bar).

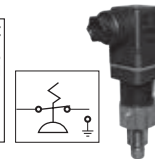
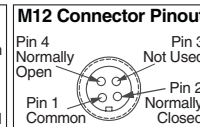
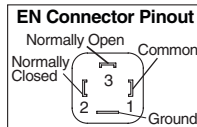

F

Preassembled Wiring Kits

SV27 Redundant PO Check valves (CAT 3), requires 2 kits.

Kit Number*	Length meters (feet)	Number of Cables
2241H77	4 (13.1)	1
2242H77	10 (32.8)	1

* Each cable has one connector.

The wiring kits include one cable with a 5-pin M12 connector for the sensing switch, and with a cord grip.

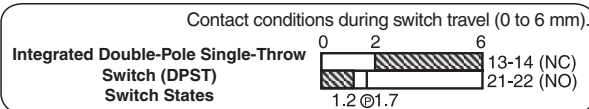

Sensing Switch Cable with 5-pin M12 Connector

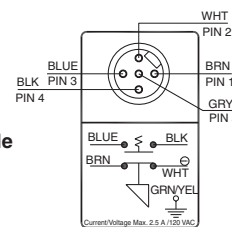

STANDARD SPECIFICATIONS (for valves on this page):

Construction: Poppet.
Mounting Type: In-Line.
Ambient Temperature: 40° to 120°F (4° to 50°C).
Media Temperature: 40° to 175°F (4° to 80°C).
Flow Media: Filtered air.
Inlet Pressure: 40 to 150 psig (2.8 to 10.3 bar).
Pilot Pressure: Must be equal to or greater than inlet pressure.
Switch Current/Voltage Max.: 2.5 A/120 volts AC.
Switch Current/Voltage Min.: 50 mA/24 volts DC.

NOTE: Electrical life of switch varies with conditions and voltage; rated in excess of 15 million cycles.

Functional Safety Data:

Category 3 PL e; B10d: Valve - 20,000,000, Switch - 2,000,000; PFHd: 2.47x10⁻⁸; MTTFd: 100 (n_{op}: 7360); DC (obtained by monitoring safety switch status): 90%; ROSS recommends testing the switch function and sealing for load holding valves every 8 hours.

Vibration/Impact Resistance: Calculated to BS EN 60068-2-27.

IMPORTANT NOTE: Please read carefully and thoroughly all of the **CAUTIONS, WARNINGS** on the inside back cover.



General Information

Standard Specifications

The standard specifications for the products on each page of this catalog are given on the same page or referenced. For solenoid pilot valves, models with internal pilot supply are listed. Most models are also available for use with external pilot supply or have a built-in pilot supply selector valve.

The products in this catalog are intended for use in industrial pneumatic systems. Most products are adaptable to other uses and conditions not covered by the standard specifications given in this catalog. Weights shown are approximate and are subject to change. Dimensions given, unless otherwise noted, are envelope dimensions (not for mounting). Consult ROSS for further information.

Port Threads

Ports of valves and bases described in this catalog have NPT (ANSI B2.1) threads. Other thread types can be specified by putting an appropriate prefix letter on the model or part number when ordering.

Thread Types by Model Prefix Letter

Pneumatic Port Threads	Prefix Letter	Threaded Electrical Opening
NPT (ANSI B2.1)	None	NPT
ISO 228 - DIN 259 Parallel, BSPP [#]	C*	—
ISO 228 - DIN 259 Parallel, BSPP [#]	D	G
ISO 228 - JIS B0203 Tapered [#]	J	ISO
SAE 1926- ISO 11926	S	NPT

* Used only for filters, regulators, lubricators.

[#] ISO 228 threads supersedes BSPP, G and JIS thread types.

Flow Ratings

Flow ratings are expressed as C_v where $C_v = 1$ corresponds to a steady state air flow of approximately 32 scfm under the following conditions:

Inlet pressure = 100 psig (6.7 bar)
Pressure drop = 10 psi (0.69 bar)
Air temperature = 68°F (20°C)
Relative humidity = 36%

Note: Because widely differing test standards are used to measure C_v values, the figures given in this catalog should not be used to compare ROSS valves with those of other makers. The C_v ratings given here are intended only for use with performance charts published by ROSS. The C_v ratings are averages for the various flow paths through the valve and are for steady flow conditions.

Approvals and Certifications

ROSS products are designed to meet a number of industrial standards, including the Canadian Standards Association (C.S.A.) guidelines. For more information on specific product approvals, contact your local distributor or ROSS.

Solenoids

All ROSS standard solenoids are rated for continuous duty (unless noted otherwise) and will operate the valve within the air pressure range specified in this catalog.

Explosion-Proof Solenoid Pilot available, for more information consult ROSS.

Voltage & Hertz

When ordering a solenoid valve, also specify the desired solenoid voltage and hertz.

Voltage Types by Model Suffix Letter

Voltage	Suffix Letter
120 volts AC	Z
220 volts AC	Y
12 volts DC	H
24 volts DC	W
48 volts DC	M
90 volts DC	K
110 volts DC	P
125 volts DC	C

Recommended Solenoid Voltages: 100-110 volts AC, 50 Hz; 100-120 volts AC, 60 Hz; 24 volts DC; 110 volts DC.

In addition, the following voltages are available:

200, 220 volts AC, 50 Hz
200, 240, 480 volts AC, 60 Hz
24, 48, 220 volts AC, 50 Hz
240 volts AC, 60 Hz
200, 220 volts AC, 50 Hz
200, 240 volts AC, 60 Hz.

For example: Model 2773B5001, 120 volts AC, 60 Hz.
Model W6076B2401, 220 volts AC, 50 Hz.

Please note that not all configurations are available for all models.

For additional information or help with voltage configuration, please contact your local distributor or ROSS.

Port Identification

Valve symbols in this catalog conform to the ISO 1219-1:1991 standard of the International Organization for Standardization (ISO) and the SAE J2051 standard of the Society of Automotive Engineers (SAE) respectively.

Information or Technical Assistance

For additional information or application assistance concerning ROSS products, consult ROSS or your local ROSS distributor (see contact information on the back cover).

Order Placement

For order placement, consult ROSS or your local ROSS distributor.

For a current list of countries and local distributors, visit ROSS' website at www.rosscontrols.com.

CAUTIONS, WARNINGS and STANDARD WARRANTY

PRE-INSTALLATION or SERVICE

1. Before servicing a valve or other pneumatic component, be sure that all sources of energy are turned off, the entire pneumatic system is shut off and exhausted, and all power sources are locked out (ref: OSHA 1910.147, EN 1037).
2. All ROSS products, including service kits and parts, should be installed and/or serviced only by persons having training and experience with pneumatic equipment. Because any installation can be tampered with or need servicing after installation, persons responsible for the safety of others or the care of equipment must check every installation on a regular basis and perform all necessary maintenance.
3. All applicable instructions should be read and complied with before using any fluid power system in order to prevent harm to persons or equipment. In addition, overhauled or serviced valves must be functionally tested prior to installation and use. If you have any questions, call your nearest ROSS location listed on the cover of this document.
4. Each ROSS product should be used within its specification limits. In addition, use only ROSS parts to repair ROSS products.

WARNING: Failure to follow these directions can adversely affect the performance of the product or result in the potential for human injury or damage to property.

FILTRATION and LUBRICATION

5. Dirt, scale, moisture, etc. are present in virtually every air system. Although some valves are more tolerant of these contaminants than others, best performance will be realized if a filter is installed to clean the air supply, thus preventing contaminants from interfering with the proper performance of the equipment. ROSS recommends a filter with a 5-micron rating for normal applications.
6. All standard ROSS filters and lubricators with polycarbonate plastic bowls are designed for compressed air applications only. Do *not* fail to use the metal bowl guard, where provided, to minimize danger from high pressure fragmentation in the event of bowl failure. Do not expose these products to certain fluids, such as alcohol or liquefied petroleum gas, as they can cause bowls to rupture, creating a combustible condition, hazardous leakage, and the potential for human injury or damage to property. Immediately replace a crazed, cracked, or deteriorated bowl. When bowl gets dirty, replace it or wipe it with a clean dry cloth.

7. Only use lubricants which are compatible with materials used in the valves and other components in the system. Normally, compatible lubricants are petroleum based oils with oxidation inhibitors, an aniline point between 180°F (82°C) and 220°F (104°C), and an ISO 32, or lighter, viscosity. Avoid oils with phosphate type additives which can harm polyurethane components, potentially leading to valve failure which risks human injury, and/or damage to property.

AVOID INTAKE/EXHAUST RESTRICTION

8. Do not restrict the air flow in the supply line. To do so could reduce the pressure of the supply air below the minimum requirements for the valve and thereby cause erratic action.
9. Do not restrict a valve's exhaust port as this can adversely affect its operation. Exhaust silencers must be resistant to clogging and must have flow capacities at least as great as the exhaust capacities of the valves. Contamination of the silencer can result in reduced flow and increased back pressure.

WARNING: ROSS expressly disclaims all warranties and responsibility for any unsatisfactory performance or injuries caused by the use of the wrong type, wrong size, or an inadequately maintained silencer installed with a ROSS product.

POWER PRESSES

10. Mechanical power presses and other potentially hazardous machinery using a pneumatically controlled clutch and brake mechanism must use a press control double valve with a monitoring device. A double valve without a self-contained monitoring device should be used only in conjunction with a control system which assures monitoring of the valve. All double valve installations involving hazardous applications should incorporate a monitoring system which inhibits further operation of the valve and machine in the event of a failure within the valve mechanism.

ENERGY ISOLATION/EMERGENCY STOP

11. Per specifications and regulations, ROSS L-O-X® and L-O-X® with EEZ-ON® operation products are defined as energy isolation devices, NOT AS EMERGENCY STOP DEVICES.

STANDARD WARRANTY

limited to repair or replacement of the product or refund of the purchase price paid solely at the discretion of ROSS and provided such product is returned to ROSS freight prepaid and upon examination by ROSS is found to be defective. This warranty becomes void in the event that product has been subject to misuse, misapplication, improper maintenance, modification or tampering.

THE WARRANTY EXPRESSED ABOVE IS IN LIEU OF AND EXCLUSIVE OF ALL OTHER WARRANTIES AND ROSS EXPRESSLY DISCLAIMS ALL OTHER WARRANTIES EITHER EXPRESSED OR IMPLIED WITH RESPECT TO MERCHANTABILITY OR FITNESS FOR A PARTICULAR PURPOSE. ROSS MAKES NO WARRANTY WITH RESPECT TO ITS PRODUCTS MEETING THE PROVISIONS OF ANY GOVERNMENTAL OCCUPATIONAL SAFETY AND/OR HEALTH LAWS OR REGULATIONS. IN NO EVENT IS ROSS LIABLE TO PURCHASER, USER, THEIR EMPLOYEES OR OTHERS FOR INCIDENTAL OR CONSEQUENTIAL DAMAGES WHICH MAY RESULT FROM A BREACH OF THE WARRANTY DESCRIBED ABOVE OR THE USE OR MISUSE OF THE PRODUCTS. NO STATEMENT OF ANY REPRESENTATIVE OR EMPLOYEE OF ROSS MAY EXTEND THE LIABILITY OF ROSS AS SET FORTH HEREIN.

All products sold by ROSS CONTROLS are warranted for a one-year period [with the exception of all Filters, Regulators and Lubricators ("FRLs") which are warranted for a period of seven years] from the date of purchase to be free of defects in material and workmanship. ROSS' obligation under this warranty is

