

**ROSS CONTROLS®**



---

**MINIATURE VALVES W14 SERIES**  
**SOLENOID PILOT PACK VALVES SERIES**

---

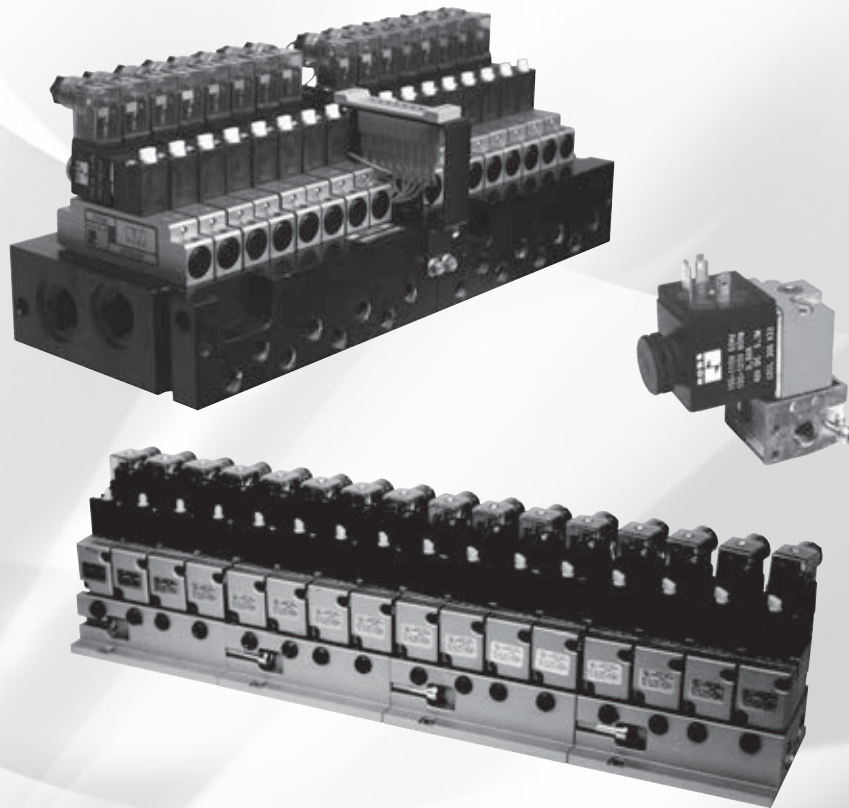

**SOLENOID PILOT CONTROLLED PACK VALVES – KEY FEATURES**

- Individual Valve Shut-off (automatic): increases uptime for continuous processing
- Sure-Shifting and Self-Cleaning: reliable performance in extreme conditions (dirt tolerant, high humidity, cold, heat, dust, debris returned from the field actuator, etc...)
- Easily Accessible Manual Override (Yellow): turn to actuate, no tools needed
- Positive Sealing and Self-Compensating for Wear: perpendicular poppet face seals
- Quick Electrical Disconnect w/Indicator Light: allows immediate troubleshooting of component/system issues in the field.
- Consistent Actuation over the Life of the Valve: strong shifting forces
- Explosion Proof & Intrinsically Safe - options available, consult ROSS
- 8 & 16 Station Valve/Manifold: flying wire leads or central wiring option

CONTENT	Page
Solenoid Pilot Controlled Miniature Valves	A7.3
4-Way Solenoid Pilot Controlled Pack Valves	A7.4
3-Way Solenoid Pilot Controlled Pack Valves	A7.5

# Solenoid Pilot Controlled Miniature Valves

# W14 Series

**A**



3-Way 2-Position Valves, Single Direct Solenoid, Spring Return			
Override Type	Valve Model Number*	C <sub>v</sub>	 3/2 Normally Closed
Locking	W1413A1408**	0.1	
Non-Locking	W1413A1409**	0.1	

\* Sub-bases and sub-base manifold ordered separately.  
 \*\* Insert voltage code: "W" = 24 volts DC; "Z" = 110-120 volts AC, 50/60 Hz; e.g., W1413A1408W.  
 For other voltages, consult ROSS.

Manifold	Model Number
	535K91

Sub-Base	Port Threads	Model Number
	1/8 NPT	516B91
	1/8 BSPP	D516B91

### Dimensions – inches (mm)

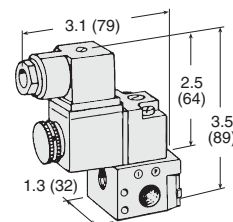
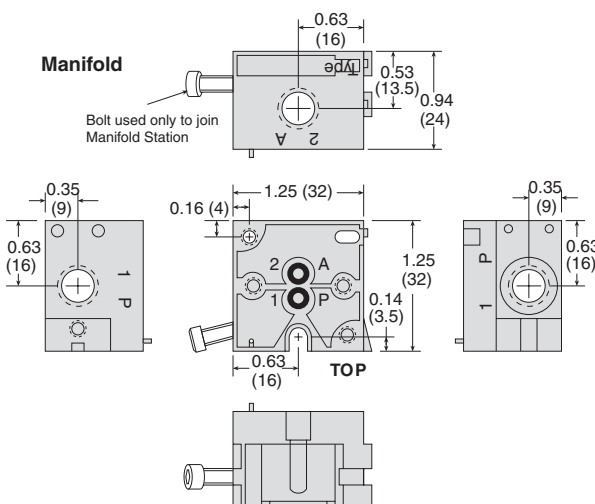
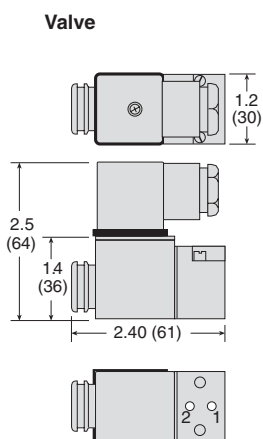

Valve is shown with electrical connector and on a base. Electrical connector, optional.

### ACCESSORIES

Electrical Connectors 	Electrical Connector Form	Electrical Connector Type	Cord Length meters (feet)	Cord Diameter	Electrical Connector Model Number		
					Without Light	Lighted Connector*	
						24 Volts DC	120 Volts AC
	EN 175301-803 Form A	Prewired Connector (18 gauge)	2 (6½)	6-mm	721K77	720K77-W	720K77-Z
	EN 175301-803 Form A	Prewired Connector (18 gauge)	2 (6½)	10-mm	371K77	383K77-W	383K77-Z
	EN 175301-803 Form A	Connector for threaded conduit (1/2 inch electrical conduit fittings)	–	–	723K77	724K77-W	724K77-Z
	EN 175301-803 Form A	Connector Only	–	–	937K87	936K87-W	936K87-Z

\* Lights in connectors with a translucent housing can be used as indicator lights to show when solenoids are energized.

**A7**

### STANDARD SPECIFICATIONS (for valves on this page):

**Construction:** Poppet.  
**Mounting Type:** Base.  
**Solenoid Pilot:** Rated for continuous duty.  
**Standard Voltages:** 24 volts DC; 110-120 volts AC, 50/60 Hz.  
**Power Consumption:** 8 VA inrush, 6 VA holding on 50 or 60 Hz; 6 watts on DC.  
**Enclosure Rating:** IP65, IEC 60529.  
**Electrical Connections:** EN 175301-803 Form A connector.

**Ambient Temperature:** 5° to 120°F (-15° to 50°C).  
**Media Temperature:** 5° to 175°F (-15° to 80°C).  
 For temperatures below 40°F (4°C) air must be free of water vapor to prevent formation of ice.  
**Flow Media:** Filtered air.  
**Inlet Pressure:** Vacuum to 150 psig (10 bar).  
**Manual Override:** Flush; metal, locking and non-locking.

**IMPORTANT NOTE:** Please read carefully and thoroughly all of the **CAUTIONS, WARNINGS** on the inside back cover.



Online Version  
Rev. 11/14/16

www.rosscontrols.com

A7.3

**A**

5-Way 2-Position Valves, Single Solenoid Pilot Controlled		
Valve/Manifold Assembly	Model Number	C <sub>v</sub>
4 Station	3900A1052-1**	0.5
8 Station	3900A1052-2**	0.5
12 Station	3900A1052-3**	0.5
16 Station	3900A1052-4**	0.5
20 Station and over	consult ROSS	0.5

\*\* Insert voltage code: "W" = 24 volts DC; "Z" = 110-120 volts AC, 50/60 Hz; e.g., 3900A1052-1W. For other voltages, consult ROSS.

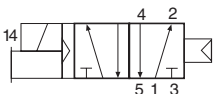
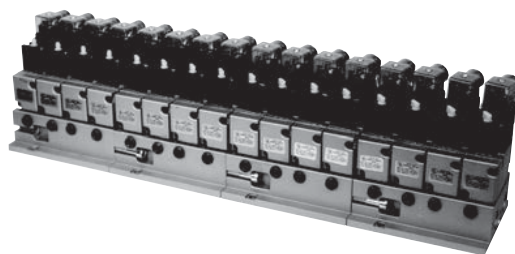

### Dimensions – inches (mm)

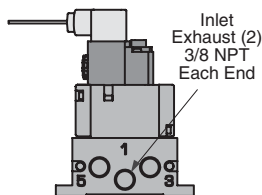
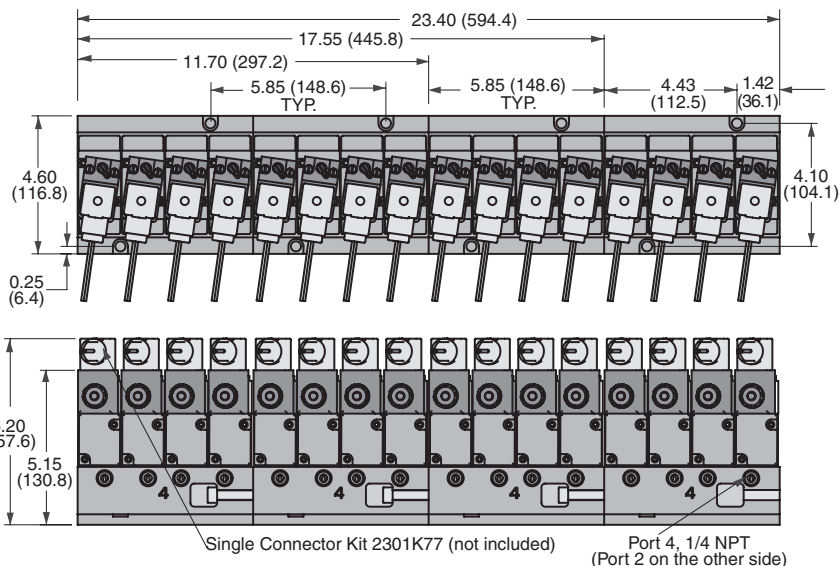

### ACCESSORIES & OPTIONS

#### Silencers

Port Size	Thread Type	Model Number	
		NPT Threads	BSPT Threads
3/8	Male	5500A3013	D5500A3013
1/2	Male	5500A4003	D5500A3003

**Pressure Range:** 0 to 150 psig (0 to 10.3 bar) maximum.  
**Flow Media:** Filtered air.



Fitting	Fitting Type	Port Threads	Model Number*
	Brass Swivel	1/4	270A27

\*1/4 tube.

Electrical Connector	Connector Type	Model Number*
	EN 175301-803 Form A	2301K77

\* Electrical Connector w/10' leads.

For dual or spring return actuators. Field convertible to a 3/2 Valve.

### STANDARD SPECIFICATIONS (for valves on this page):

**Construction:** Poppet.  
**Mounting Type:** Base.  
**Solenoids:** Rated for continuous duty.  
**Standard Voltages:** 24 volts DC; 110-120 volts AC, 50/60 Hz.  
**Power Consumption:** 3.9 VA holding on 50/60 Hz; 2.1 watts on DC.  
**Enclosure Rating:** IP65, IEC 60529.

**Electrical Connections:** EN 175301-803 Form A connector.  
**Ambient Temperature:** 39° to 122°F (4° to 50°F).  
**Media Temperature:** 39° to 175°F (4° to 80°C).  
**Indicator Light:** In connector.  
**Flow Media:** Filtered air.  
**Inlet Pressure:** 30 to 150 psig (2 to 10 bar).

**IMPORTANT NOTE:** Please read carefully and thoroughly all of the **CAUTIONS, WARNINGS** on the inside back cover.



# 3-Way Solenoid Pilot Controlled Pack Valves

# Pack Series

A

3-Way 2-Position Valves - Extended-Duty, Single Solenoid Pilot Controlled			
Valve/Manifold Assembly	Model Number		C <sub>v</sub>
	Flying Leads	Central Wiring	
8 Station	3900A0713-1**	3900A1055-1**	0.5
16 Station	3900A0713-2**	3900A1055-2**	0.5
24 Station and over	consult ROSS	consult ROSS	0.5

\*\* Insert voltage code: "W" = 24 volts DC; "Z" = 110-120 volts AC, 50/60 Hz; e.g., 3900A1052-1W. For other voltages, consult ROSS.

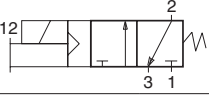
3/2 Normally Closed 

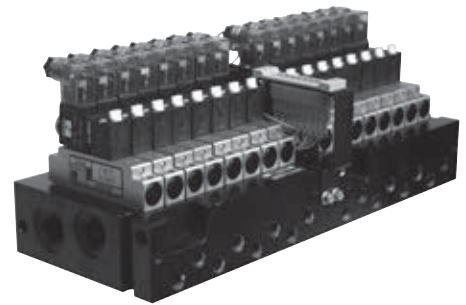

### Dimensions – inches (mm)

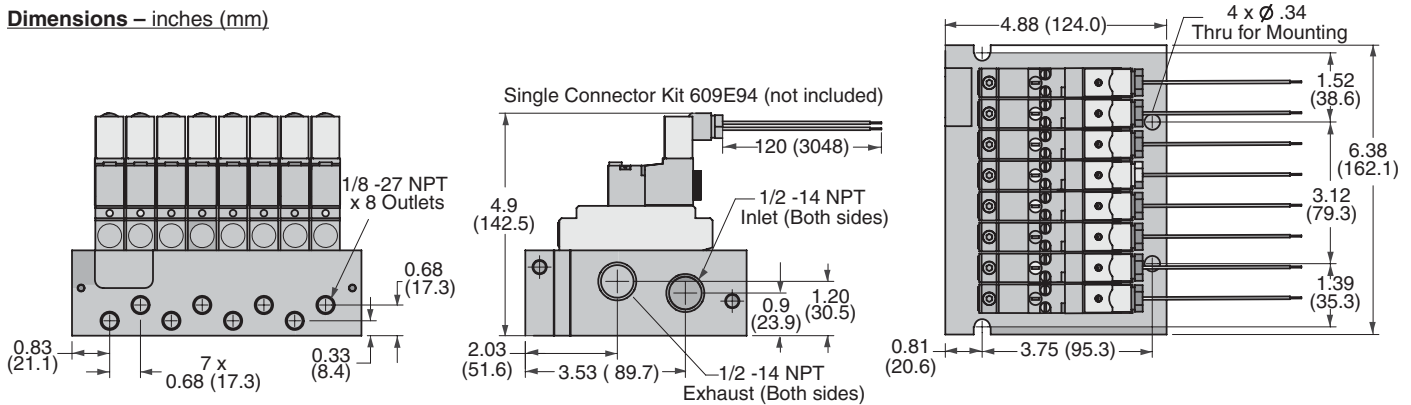

### ACCESSORIES & OPTIONS

#### Silencers

Port Size	Thread Type	Model Number	
		NPT Threads	BSPT Threads
3/8	Male	5500A3013	D5500A3013
1/2	Male	5500A4003	D5500A3003

**Pressure Range:** 0 to 150 psig (0 to 10.3 bar) maximum.  
**Flow Media:** Filtered air.



Fitting	Fitting Type	Port Threads	Model Number*	
			Flying Leads	Central Wiring
	Metal Swivel	1/8	322E27	322E27

\*1/4 tube.

Electrical Connector	Connector Type	Model Number	
		Flying Leads	Central Wiring
	EN 175301-803 Form C	609E94	consult ROSS

\* Electrical Connector w/10' leads.

**Individual Valve Shut-off (automatic):** Individual valves can be removed without shutting off main air supply to the whole manifold or entire solenoid cabinet.

- Simply remove the valve and an internal check-ball automatically blocks inlet air to that station
- Inlet air is automatically restored to the station when the valve is returned

**4/2 Low-Power Solenoid Pilot Controlled Valves available, consult ROSS.**

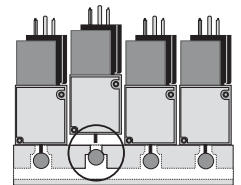

A7

### STANDARD SPECIFICATIONS (for valves on this page):

**Construction:** Poppet.  
**Mounting Type:** Base.  
**Solenoids:** Rated for continuous duty.  
**Standard Voltages:** 24 volts DC; 110-120 volts AC, 50/60 Hz.  
**Power Consumption:** 0.03 VA holding on 50/60 Hz; 0.8 watts on DC.  
**Enclosure Rating:** IP65, IEC 60529.

**Electrical Connections:** EN 175301-803 Form C connector.  
**Ambient Temperature:** 39° to 122°F (4° to 50°F).  
**Media Temperature:** 39° to 175°F (4° to 80°C).  
**Indicator Light:** In connector.  
**Flow Media:** Filtered air.  
**Inlet Pressure:** 30 to 150 psig (2 to 10 bar).

**IMPORTANT NOTE:** Please read carefully and thoroughly all of the **CAUTIONS, WARNINGS** on the inside back cover.



Online Version  
Rev. 11/14/16

[www.rosscontrols.com](http://www.rosscontrols.com)

A7.5

# General Information

## Standard Specifications

The standard specifications for the products on each page of this catalog are given on the same page or referenced. For solenoid pilot valves, models with internal pilot supply are listed. Most models are also available for use with external pilot supply or have a built-in pilot supply selector valve.

The products in this catalog are intended for use in industrial pneumatic systems. Most products are adaptable to other uses and conditions not covered by the standard specifications given in this catalog. Weights shown are approximate and are subject to change. Dimensions given, unless otherwise noted, are envelope dimensions (not for mounting). Consult ROSS for further information.

## Port Threads

Ports of valves and bases described in this catalog have NPT (ANSI B2.1) threads. Other thread types can be specified by putting an appropriate prefix letter on the model or part number when ordering.

Thread Types by Model Prefix Letter

Pneumatic Port Threads	Prefix Letter	Threaded Electrical Opening
NPT (ANSI B2.1)	None	NPT
ISO 228 - DIN 259 Parallel, BSPP <sup>#</sup>	C*	—
ISO 228 - DIN 259 Parallel, BSPP <sup>#</sup>	D	G
ISO 228 - JIS B0203 Tapered <sup>#</sup>	J	ISO
SAE 1926- ISO 11926	S	NPT

\* Used only for filters, regulators, lubricators.

<sup>#</sup> ISO 228 threads supersedes BSPP, G and JIS thread types.

## Flow Ratings

Flow ratings are expressed as  $C_v$  where  $C_v = 1$  corresponds to a steady state air flow of approximately 32 scfm under the following conditions:

Inlet pressure = 100 psig (6.7 bar)  
Pressure drop = 10 psi (0.69 bar)  
Air temperature = 68°F (20°C)  
Relative humidity = 36%

**Note:** Because widely differing test standards are used to measure  $C_v$  values, the figures given in this catalog should not be used to compare ROSS valves with those of other makers. The  $C_v$  ratings given here are intended only for use with performance charts published by ROSS. The  $C_v$  ratings are averages for the various flow paths through the valve and are for steady flow conditions.

## Approvals and Certifications

ROSS products are designed to meet a number of industrial standards, including the Canadian Standards Association (C.S.A.) guidelines. For more information on specific product approvals, contact your local distributor or ROSS.

## Solenoids

All ROSS standard solenoids are rated for continuous duty (unless noted otherwise) and will operate the valve within the air pressure range specified in this catalog.

**Explosion-Proof Solenoid Pilot available, for more information consult ROSS.**

## Voltage & Hertz

When ordering a solenoid valve, also specify the desired solenoid voltage and hertz.

Voltage Types by Model Suffix Letter

Voltage	Suffix Letter
120 volts AC	Z
220 volts AC	Y
12 volts DC	H
24 volts DC	W
48 volts DC	M
90 volts DC	K
110 volts DC	P
125 volts DC	C

**Recommended Solenoid Voltages:** 100-110 volts AC, 50 Hz; 100-120 volts AC, 60 Hz; 24 volts DC; 110 volts DC.

In addition, the following voltages are available:

200, 220 volts AC, 50 Hz  
200, 240, 480 volts AC, 60 Hz  
24, 48, 220 volts AC, 50 Hz  
240 volts AC, 60 Hz  
200, 220 volts AC, 50 Hz  
200, 240 volts AC, 60 Hz.

For example: Model 2773B5001, 120 volts AC, 60 Hz.  
Model W6076B2401, 220 volts AC, 50 Hz.

**Please note that not all configurations are available for all models.**

*For additional information or help with voltage configuration, please contact your local distributor or ROSS.*

## Port Identification

Valve symbols in this catalog conform to the ISO 1219-1:1991 standard of the International Organization for Standardization (ISO) and the SAE J2051 standard of the Society of Automotive Engineers (SAE) respectively.

## Information or Technical Assistance

*For additional information or application assistance concerning ROSS products, consult ROSS or your local ROSS distributor (see contact information on the back cover).*

## Order Placement

**For order placement, consult ROSS or your local ROSS distributor.**

For a current list of countries and local distributors, visit ROSS' website at [www.rosscontrols.com](http://www.rosscontrols.com).

# CAUTIONS, WARNINGS and STANDARD WARRANTY

## PRE-INSTALLATION or SERVICE

1. Before servicing a valve or other pneumatic component, be sure that all sources of energy are turned off, the entire pneumatic system is shut off and exhausted, and all power sources are locked out (ref: OSHA 1910.147, EN 1037).
2. All ROSS products, including service kits and parts, should be installed and/or serviced only by persons having training and experience with pneumatic equipment. Because any installation can be tampered with or need servicing after installation, persons responsible for the safety of others or the care of equipment must check every installation on a regular basis and perform all necessary maintenance.
3. All applicable instructions should be read and complied with before using any fluid power system in order to prevent harm to persons or equipment. In addition, overhauled or serviced valves must be functionally tested prior to installation and use. If you have any questions, call your nearest ROSS location listed on the cover of this document.
4. Each ROSS product should be used within its specification limits. In addition, use only ROSS parts to repair ROSS products.

**WARNING: Failure to follow these directions can adversely affect the performance of the product or result in the potential for human injury or damage to property.**

## FILTRATION and LUBRICATION

5. Dirt, scale, moisture, etc. are present in virtually every air system. Although some valves are more tolerant of these contaminants than others, best performance will be realized if a filter is installed to clean the air supply, thus preventing contaminants from interfering with the proper performance of the equipment. ROSS recommends a filter with a 5-micron rating for normal applications.
6. All standard ROSS filters and lubricators with polycarbonate plastic bowls are designed for compressed air applications only. Do *not* fail to use the metal bowl guard, where provided, to minimize danger from high pressure fragmentation in the event of bowl failure. Do not expose these products to certain fluids, such as alcohol or liquefied petroleum gas, as they can cause bowls to rupture, creating a combustible condition, hazardous leakage, and the potential for human injury or damage to property. Immediately replace a crazed, cracked, or deteriorated bowl. When bowl gets dirty, replace it or wipe it with a clean dry cloth.

7. Only use lubricants which are compatible with materials used in the valves and other components in the system. Normally, compatible lubricants are petroleum based oils with oxidation inhibitors, an aniline point between 180°F (82°C) and 220°F (104°C), and an ISO 32, or lighter, viscosity. Avoid oils with phosphate type additives which can harm polyurethane components, potentially leading to valve failure which risks human injury, and/or damage to property.

## AVOID INTAKE/EXHAUST RESTRICTION

8. Do not restrict the air flow in the supply line. To do so could reduce the pressure of the supply air below the minimum requirements for the valve and thereby cause erratic action.
9. Do not restrict a valve's exhaust port as this can adversely affect its operation. Exhaust silencers must be resistant to clogging and must have flow capacities at least as great as the exhaust capacities of the valves. Contamination of the silencer can result in reduced flow and increased back pressure.

**WARNING: ROSS expressly disclaims all warranties and responsibility for any unsatisfactory performance or injuries caused by the use of the wrong type, wrong size, or an inadequately maintained silencer installed with a ROSS product.**

## POWER PRESSES

10. Mechanical power presses and other potentially hazardous machinery using a pneumatically controlled clutch and brake mechanism must use a press control double valve with a monitoring device. A double valve without a self-contained monitoring device should be used only in conjunction with a control system which assures monitoring of the valve. All double valve installations involving hazardous applications should incorporate a monitoring system which inhibits further operation of the valve and machine in the event of a failure within the valve mechanism.

## ENERGY ISOLATION/EMERGENCY STOP

11. Per specifications and regulations, ROSS L-O-X® and L-O-X® with EEZ-ON® operation products are defined as energy isolation devices, NOT AS EMERGENCY STOP DEVICES.

## STANDARD WARRANTY

limited to repair or replacement of the product or refund of the purchase price paid solely at the discretion of ROSS and provided such product is returned to ROSS freight prepaid and upon examination by ROSS is found to be defective. This warranty becomes void in the event that product has been subject to misuse, misapplication, improper maintenance, modification or tampering.

THE WARRANTY EXPRESSED ABOVE IS IN LIEU OF AND EXCLUSIVE OF ALL OTHER WARRANTIES AND ROSS EXPRESSLY DISCLAIMS ALL OTHER WARRANTIES EITHER EXPRESSED OR IMPLIED WITH RESPECT TO MERCHANTABILITY OR FITNESS FOR A PARTICULAR PURPOSE. ROSS MAKES NO WARRANTY WITH RESPECT TO ITS PRODUCTS MEETING THE PROVISIONS OF ANY GOVERNMENTAL OCCUPATIONAL SAFETY AND/OR HEALTH LAWS OR REGULATIONS. IN NO EVENT IS ROSS LIABLE TO PURCHASER, USER, THEIR EMPLOYEES OR OTHERS FOR INCIDENTAL OR CONSEQUENTIAL DAMAGES WHICH MAY RESULT FROM A BREACH OF THE WARRANTY DESCRIBED ABOVE OR THE USE OR MISUSE OF THE PRODUCTS. NO STATEMENT OF ANY REPRESENTATIVE OR EMPLOYEE OF ROSS MAY EXTEND THE LIABILITY OF ROSS AS SET FORTH HEREIN.

All products sold by ROSS CONTROLS are warranted for a one-year period [with the exception of all Filters, Regulators and Lubricators ("FRLs") which are warranted for a period of seven years] from the date of purchase to be free of defects in material and workmanship. ROSS' obligation under this warranty is

